

ROLLING

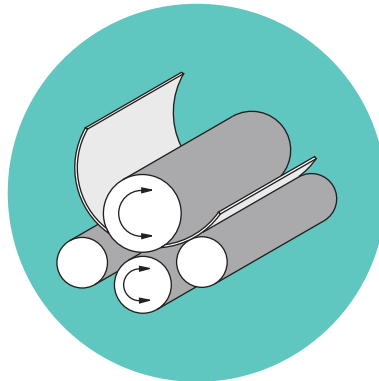

BENDROLL

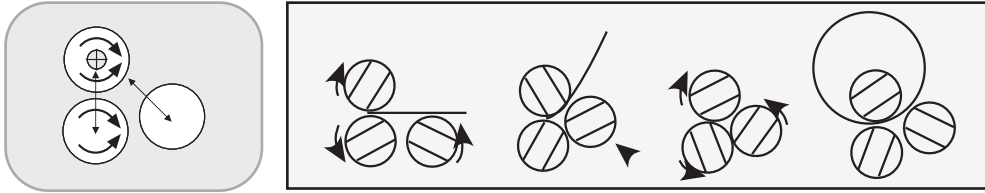



FEATURES :

- All rolls are made of polished, turned and ground high grade carbon steel.
- Rigid construction for long life & precision operation.
- Front mounted handle to lift upper roll for easy workpiece removal.
- Rolls were driven by gears.
- Wire grooves are standard.



R-2420



R-5016



R-3622E



R-5016E

SPECIFICATION

Model	R-2420	R-3622	R-5016	R-2420E	R-3622E	R-5016E
Length	610mm (24")	914mm (36")	1270mm (50")	610mm (24")	914mm (36")	1270mm (50")
Capacity (mild steel)	1.0mm (20GA)	0.8mm(22GA)	1.6mm(16GA)	1.0mm (20GA)	0.8mm(22GA)	1.6mm(16GA)
Dia. of Roll	50mm (2")	50mm (2")	75mm (3")	50mm (2")	50mm (2")	75mm (3")
Wire grooves	3	3	3	3	3	3
Minimum Forming Radius	35mm (1.4")	35mm (1.4")	50mm (2")	35mm (1.4")	35mm (1.4")	50mm (2")
Gear Ratio	1 : 1	1 : 1	3 : 1	--	--	--
Roll Sped	--	--	--	38rpm	38rpm	16rpm
Motor	--	--	--	0.5HP	0.5HP	1.0HP
Packing Size	1000x480x510mm	1350x480x510mm	1760x480x630mm	1030x580x1050mm	1350x580x110mm	1850x510x1150mm
Net Weight	50kgs	75kgs	220kgs	165kgs	200kgs	300kgs

•The above specifications subject to change without prior notice.



FINTEK INDUSTRY COMPANY LIMITED

P.O.BOX 1481 TAIPEI, TAIWAN.

TEL: +886-2-2523-6891

<http://www.fintekwell.com.tw>

FAX: +886-2-2523-5419

E-mail: fintek.tw@gmail.com



4-ROLL PLATE BENDING ROLL



4R-0660H

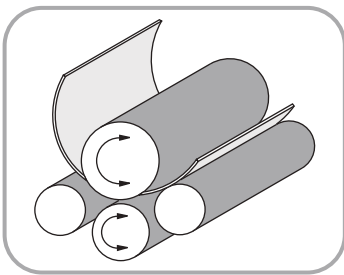

TWO DRIVING ROLLS

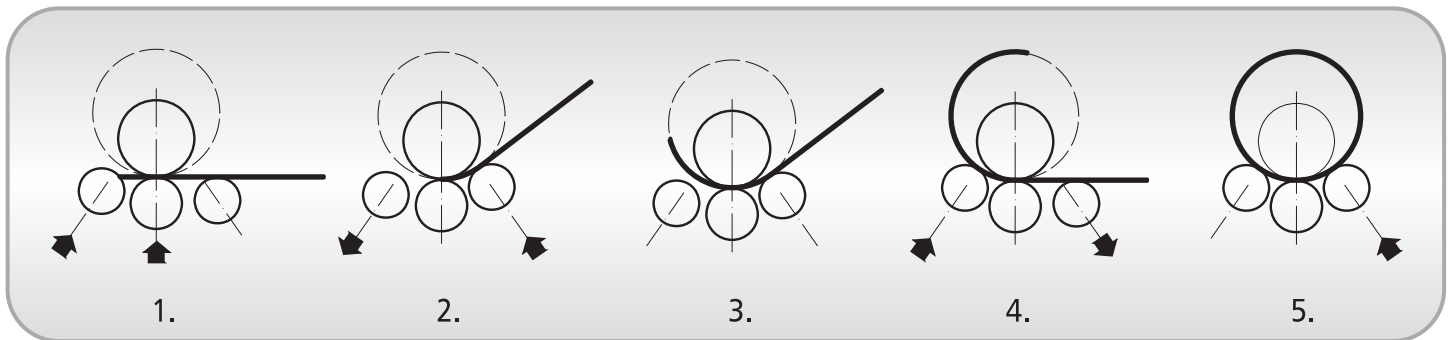

SPECIFICATION

4R-H	Model	4R-0560H	4R-0660H	4R-0860H	4R-1060H
	Work Length(mm)	1550	2050	2550	3050
Min. Diameter	Bending Capacity(mm)	10	10	10	10
= Top roll ϕ x 5	Pre-Bend Capacity (mm)	8	8	8	8
Min. Diameter	Bending Capacity(mm)	6	6	6	6
= Top roll ϕ x 1.5	Pre-Bend Capacity(mm)	6	6	6	6
	Central Rolls (mm)	190	220	240	260
	Upper Roll	170	200	210	230
	Bottom Roll				
	Side Rolls (mm)	150	180	190	210
	Motor (HP)	7.5	7.5	10	10
	Roll speed (m/min)	3.2	3.2	3.0	3.0
	Packing size (mm)	3000 x 1270 x 1370	3700 x 1300 x 1400	4500 x 1500 x 1500	5000 x 1600 x 1700
	Weight (kgs)	3800	5100	6200	7300

• The above specifications subject to change without prior notice.

STANDARD ACCESSORY

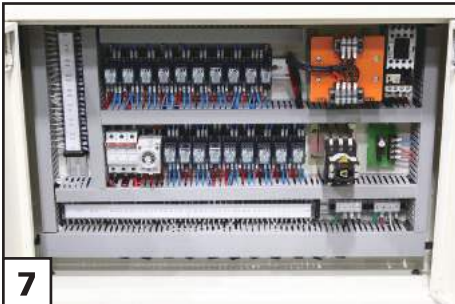
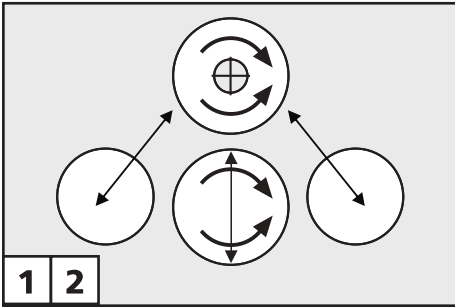

- ① Two - roll drive.
- ② Double pinch rolls.
- ③ DRO for double pinch rolls positioning.
- ④ All rolls are made of top-grade alloy steel hardened upto hrc 53°~55°.
- ⑤ Hydraulic powered pinch and rear roll adjustment.
- ⑥ Portable control panel for rolls forward/ reverse/ up & down/ pinch adjustment.
- ⑦ Hydraulic circuit is protected against overload and fully enclosed to provide low-noise & leak proof flow system.
- ⑧ Cone attachment.
- ⑨ Hydraulic powered drop end.

OPTIONAL ACCESSORY

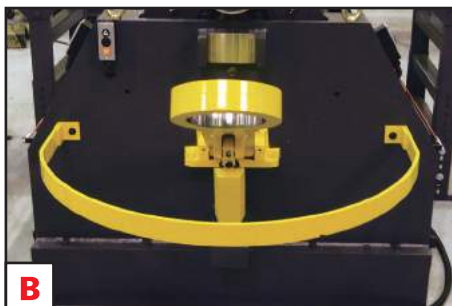

- Ⓐ Roll feeding table.
- Ⓑ Safety railing of outboard end.
- Ⓒ Wireless remote control unit.(Instead of portable controller)
- Ⓓ CE conformity machine.
- Ⓔ Infinitely variable roll rotation speed.



Each pinch roll has led indicator to show position.



HR-0813

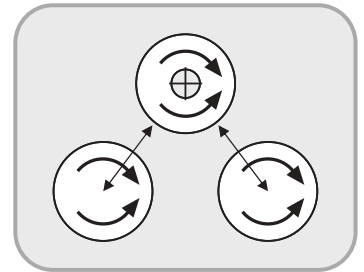

**DOUBLE PINCH
PLATE BENDING ROLL**



HR-1006

SPECIFICATION

* OEM order is welcome.

Model	HR-0506	HR-0606	HR-0805	HR-1004	HR-0508	HR-0608	HR-0806	HR-1005	HR-0510
Mild-steel capacity	1550 x 6.5mm	2050 x 6.5mm	2550 x 5.0mm	3050 x 4.5mm	1550 x 8.0mm	2050 x 8.0mm	2550 x 6.5mm	3050 x 5.0mm	1550 x 10mm
Roll diameter	ø205mm	ø205mm	ø205mm	ø205mm	ø230mm	ø230mm	ø230mm	ø230mm	ø255mm
Motor	3HP	3HP	3HP	3HP	5HP	5HP	5HP	5HP	7.5HP
Roll speed	2.25m/min	2.25m/min	2.25m/min	2.25m/min	2.20m/min	2.20m/min	2.20m/min	2.20m/min	2.15m/min
Packing size L x W x H	3600 x 1100 x 1560mm	4000 x 1100 x 1600mm	4600 x 1100 x 1620mm	5100 x 1100 x 1650mm	3900 x 1400 x 1740mm	4400 x 1400 x 1750mm	4900 x 1400 x 1750mm	5400 x 1400 x 1750mm	3850 x 1400 x 1750mm
Packing weight	3300kgs	3700kgs	4300kgs	4750kgs	4700kgs	4400kgs	5600kgs	6000kgs	5000kgs

Model	HR-0610	HR-0808	HR-1006	HR-0613	HR-0810	HR-1008	HR-0616	HR-0813	HR-1010
Mild-steel capacity	2050 x 10mm	2550 x 8.0mm	3050 x 6.5mm	2050 x 13mm	2550 x 10mm	3050 x 8.0mm	2050 x 16mm	2550 x 13mm	3050 x 10mm
Roll diameter	ø255mm	ø255mm	ø255mm	ø280mm	ø280mm	ø280mm	ø310mm	ø310mm	ø310mm
Motor	7.5HP	7.5HP	7.5HP	10HP	10HP	10HP	15HP	15HP	15HP
Roll speed	2.15m/min	2.15m/min	2.15m/min	2.0m/min	2.0m/min	2.0m/min	2.0m/min	2.0m/min	2.0m/min
Packing size L x W x H	4350 x 1400 x 1740mm	4900 x 1400 x 1750mm	5400 x 1400 x 1750mm	4600 x 1500 x 1940mm	5000 x 1500 x 1940mm	5400 x 1500 x 1940mm	5000 x 1600 x 1940mm	5200 x 1600 x 2050mm	5500 x 1600 x 2050mm
Packing weight	5750kgs	6500kgs	7000kgs	7710kgs	9100kgs	10200kgs	9100kgs	10200kgs	11300kgs

• The above specifications subject to change without prior notice.

STANDARD ACCESSORY



The drop end is tilted hydraulically at the outboard end of the top roll journal for easy removal of the finished cylinder. The drop end is strongly constructed & made to eliminate twist tendency of drop end from bending force.



PLANETARY REDUCTION GEAR & PUMP

The planetary reduction gear & pump produce maximum torque, driving the rolls powerfully & smoothly.

ROLLS CAMBER DESIGN

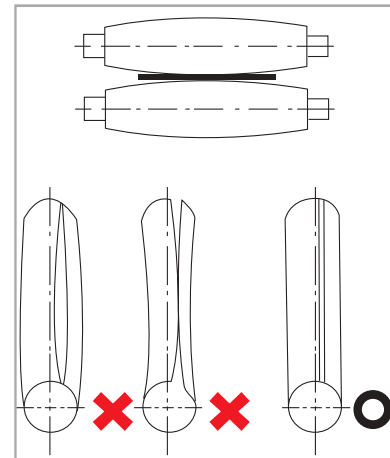

The rolls are also manufactured in a camber design to compensate any distortion of the rolls from pressure during bending process, this design can avoid to have finished cylinder with a convex or concave shape.

- 1 Hydraulic circuits, which is protected against overload, is fully enclosed to provide low-noise & leak-proof flow system.
- 2 All three rolls rotation are driven independently & hydraulically.
- 3 Hydraulic pinch adjustment for each side roll.
- 4 Each side / pinch roll is equipped with an easy-reading led indicator to show its reference position.
- 5 Portable controller around the machine for rolls forward/reverse/ pinch adjustment.
- 6 All rolls are made of top-grade alloy steel hardened upto hrc 53°~55°.
- 7 Spherical roller bearings, which are very high quality made & sealed-in against dirt & dust, are installed for all rolls.

OPTIONAL ACCESSORY

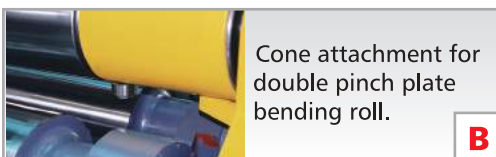

OVERHEAD SUPPORT DEVICE

HYDRAULICALLY OPERATED SIDE SUPPORT DEVICE.

- A** Infinitely variable roll rotation speed.
- B** Cone bending attachment.
- C** Wireless remote control unit. (Instead of portable controller)
- D** Overhead support device.
- E** Hydraulically operated side support device.
- F** CE conformity machine.



PR-0545H



PR-0425H



PR-0650H

SPECIFICATION

Model	PR-0425H	PR-0520H	PR-0440H	PR-0535H	PR-0625H	PR-0465H	PR-0545H	
Capacity in mild steel	2.5 x 1300mm	2.0 x 1550mm	4.0 x 1300mm	3.5 x 1550mm	2.5 x 2050mm	6.5 x 1300mm	4.5 x 1550mm	4
Roll diameter	95mm	95mm	120mm	120mm	120mm	150mm	150mm	
Hydraulic powered pinch adjustment	standard	standard	standard	standard	standard	standard	standard	
Motor	1.5HP	1.5HP	2HP	2HP	2HP	3HP	3HP	
Roll speed	3.6m/min	3.6m/min	2.6m/min	2.6m/min	2.6m/min	2.2m/min	2.2m/min	
Shipping crate size	2150 x 850 x 1350mm	2400 x 720 x 1120mm	2500 x 1000 x 1450mm	2700 x 1000 x 1450mm	3200 x 1000 x 1450mm	2500 x 1100 x 1500mm	2700 x 1100 x 1500mm	
Shipping weigh	650kgs	800kgs	1300kgs	1400kgs	1600kgs	1700kgs	1900kgs	

• The above specifications subject to change without prior notice.

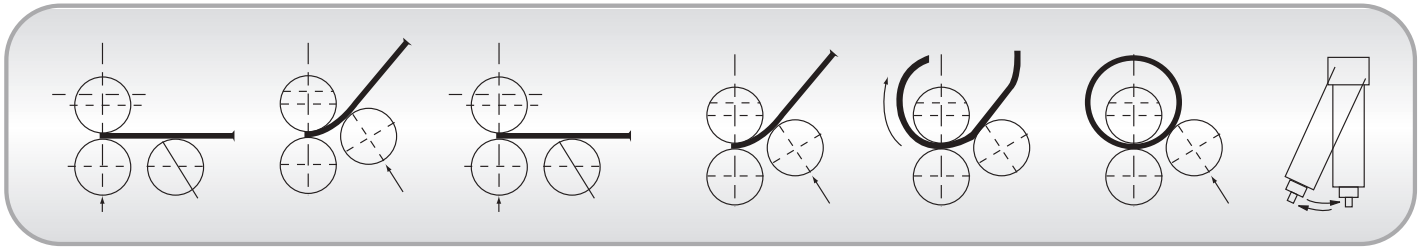

STANDARD ACCESSORY



- ① Elec. Cabinet.
- ② Foot switch with control buttons.



- ① Top roll swivel out mechanism.
- ② Pinch roll hydraulic powered.
- ③ Digital readout shows pinch Roll position.

OPTIONAL ACCESSORY



A Cone bending attachment

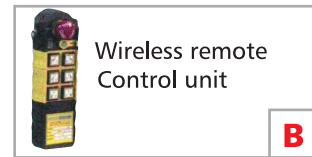

Wireless remote Control unit

B

- A** Cone bending attachment.
- B** Wireless remote control unit.
(Instead of foot switch unit)
- C** CE conformity machine.
- D** Wire grooves.

- ① All three rolls are driven by hydraulic system.
- ② Side / pinch roll cylinders adjustment synchronously.
- ③ All rolls are made of top-grade alloy steel hardened upto hrc 53°~55°.
- ④ Rigid construction for precise & smooth operation, and long life time usage.
- ⑤ The top roll can be swivelled out for easy removal of the finished workpiece.
- ⑥ Foot switch for forward/reverse, fitted with a protective housing.
- ⑦ Machine power auto shut off whenever top roll swivels out from end frame.

PR-0640H	PR-0830H	PR-0480H	PR-0570H	PR-0650H
4.0 x 2050mm	3.0 x 2540mm	8.0 x 1300mm	7.0 x 1550mm	5.0 x 2050mm
150mm	150mm	180mm	180mm	180mm
standard	standard	standard	standard	standard
3HP	3HP	5HP	5HP	5HP
2.2m/min	2.2m/min	2.37m/min	2.37m/min	2.37m/min
3200 x 1100 x 1500mm	3750 x 1100 x 1500mm	2500 x 1200 x 1530mm	2750 x 1200 x 1500mm	3250 x 1200 x 1530mm
2100kgs	2450kgs	2210kgs	2560kgs	2800kgs

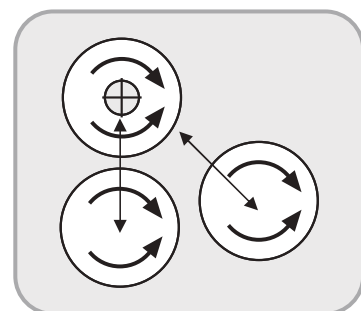

INITIAL PINCH PLATE BENDING ROLL